

DATE MAY 18, 2011	OUTLINE DIMENSIONS 3-PHASE INDUCTION MOTOR	MOTOR TYPE: AEHHXU
CATALOG NO. XP1/54		FRAME NO. 145T

Pole	HP	KW	Hz	VOLT	RPM
4	1.5	1	60	230/460	1800

Ins	Rating	Dimension in	Approx Weight	Bearings
F	CONT.	inches	70 lbs.	DE: 6205ZZ NDE: 6205ZZ

Totally Enclosed Fan-Cooled Type. Squirrel-Cage Rotor.

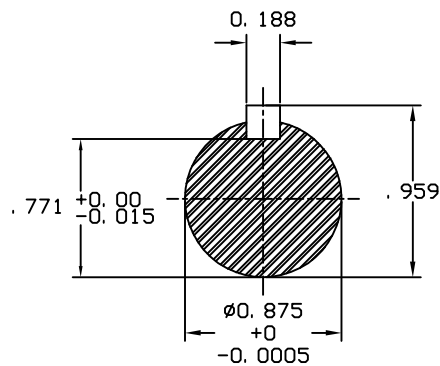
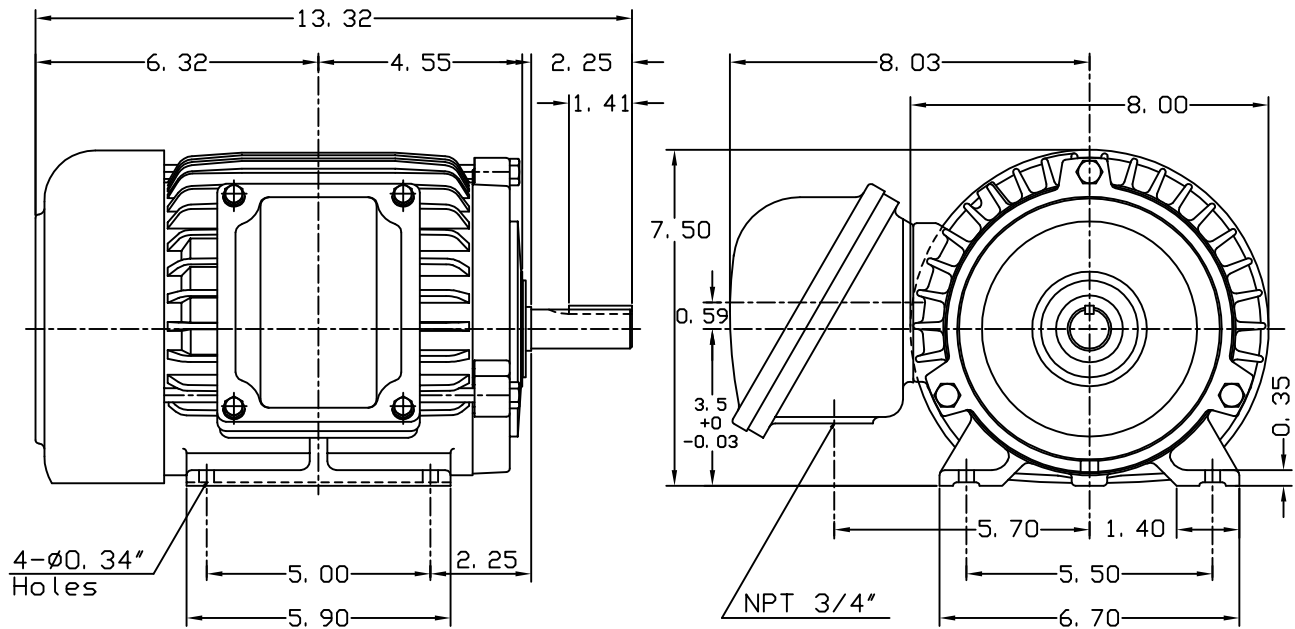

NOTE:
1. EXPLOSION PROOF:
CLASS I GROUP C, D AND
CLASS II GROUP E, F, G.



DWN.	J. H. LIANG	06-29-00
CHKD.	C. S. LO	07-06-00
APPD.	Y. B. HUANG	07-06-00

TECO Westinghouse

DWG NO.
31049H819011