

DATE
DEC. 13, 2010
CAT. #: NP0504

OUTLINE DIMENSIONS
3-PHASE INDUCTION MOTOR

MOTOR TYPE:
AEHH8P
FRAME NO. 326T

Pole	HP	kW	Hz	VOLT	Syn.Speed r/min(rpm)
4	50	37.3	50	190/380	1500

Ins	Rating	Dimension in	Approx Weight	Bearings	
F	CONT.	inch	652 lbs.	DE: 6312	NDE: 6212

Totally Enclosed Fan-Cooled Type. Squirrel-cage Rotor.

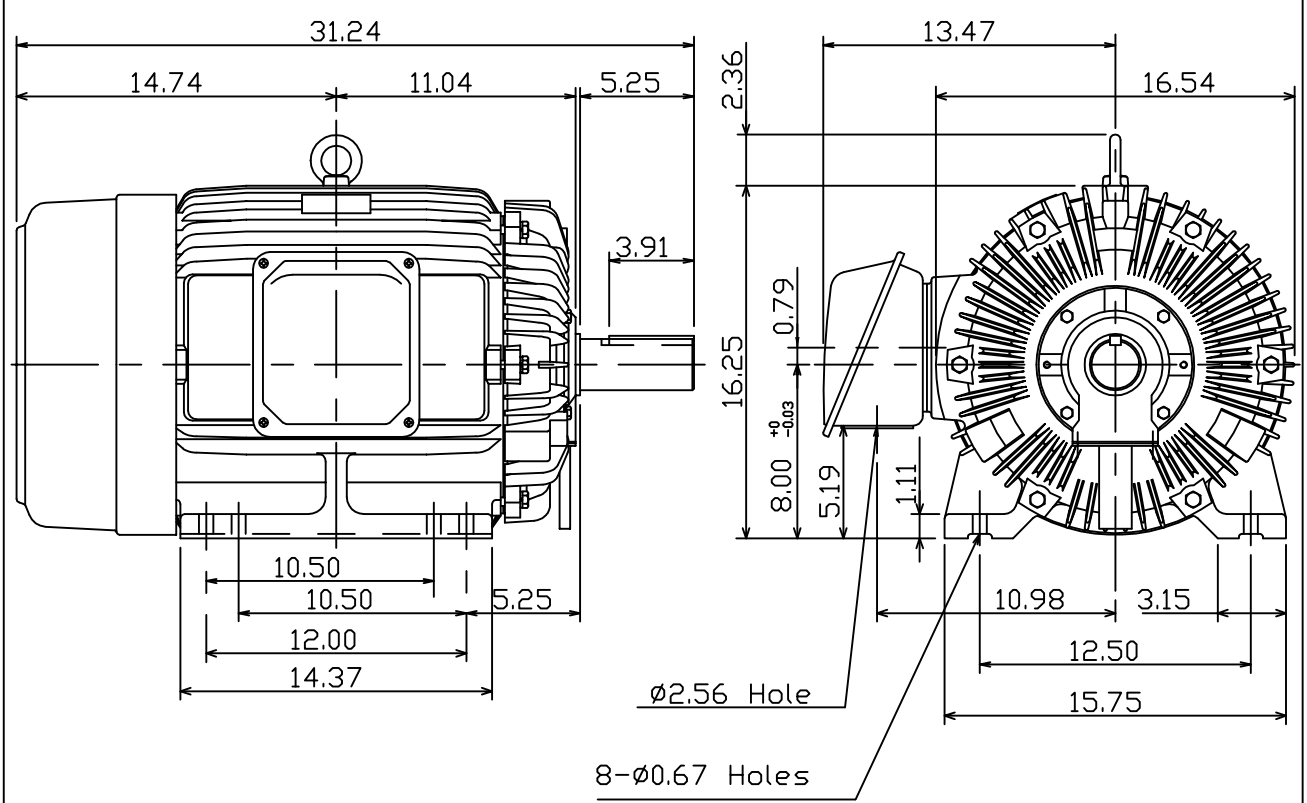

DWN.	K.L.KUD	12 06 10
CHKD.	K.L.KUD	12 07 10
APPD.	M.C.TSAI	12 07 10



DWG NO.
31049J357380