

DATE
NOV. 23, 2010

OUTLINE DIMENSIONS

3-PHASE INDUCTION MOTOR

MOTOR TYPE:
AEHH8P
FRAME NO. 184T

CAT. #: NP0054

Pole	HP	kW	Hz	VOLT	Syn.Speed r/min(rpm)
4	5	3.73	50	190/380	1500

Ins	Rating	Dimension in	Approx Weight	Bearings
F	CONT.	inch	95 lbs.	DE: 6306ZZ NDE: 6306ZZ

Totally Enclosed Fan Cooled Squirrel Cage Rotor.

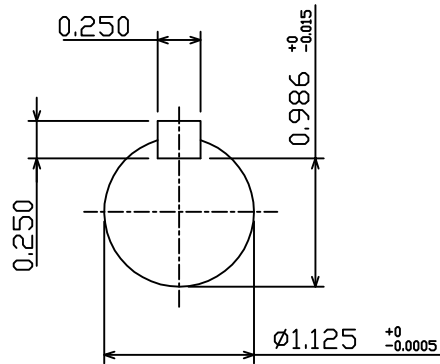
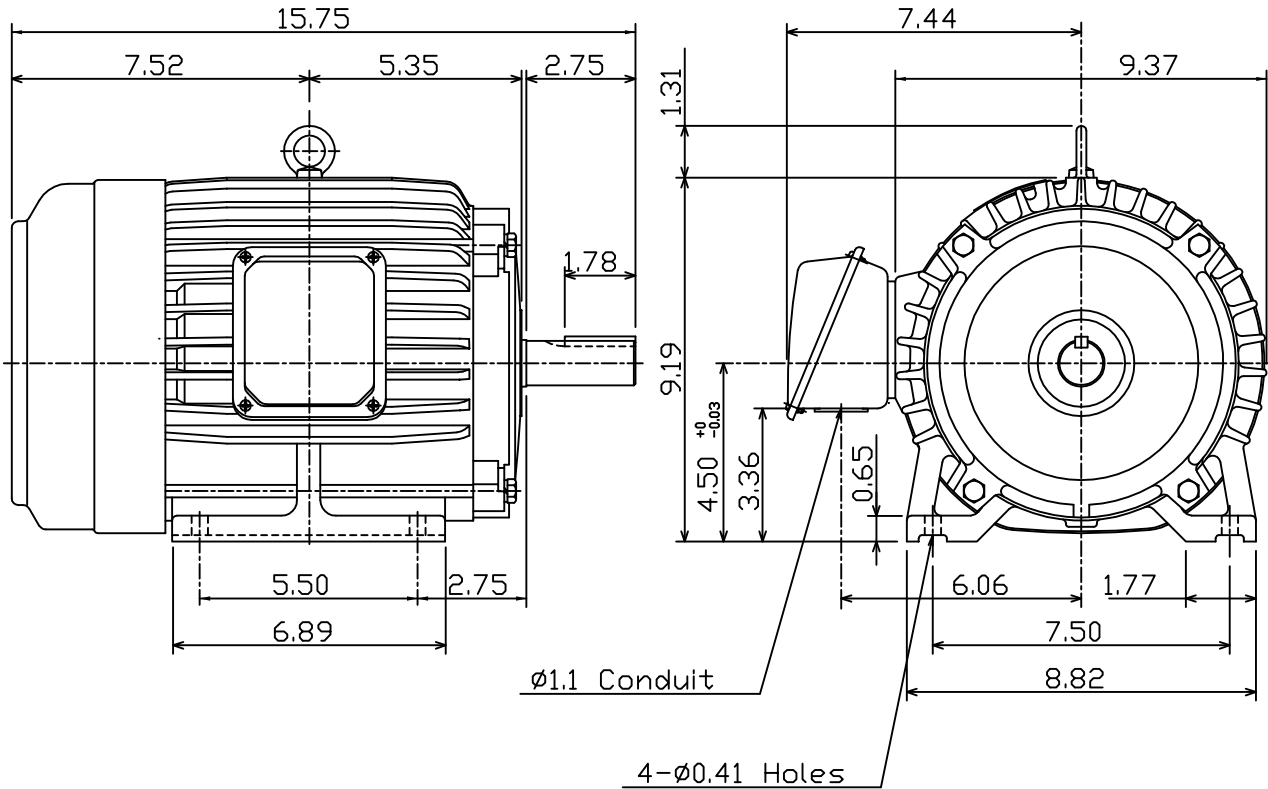

DWN.	J.H.LIANG	05-20-99
CHKD.	C.S.LO	05-26-99
APPD.	Y.B.HUANG	05-26-99

TEC   **Westinghouse**

DWG NO.
31049D190560