

DATE  
NOV. 23, 2010  
CAT. #: NP0012

OUTLINE DIMENSIONS  
3-PHASE INDUCTION MOTOR

MOTOR TYPE:  
AEHH8P  
FRAME NO. 143T

Pole	HP	kW	Hz	VOLT	Syn.Speed r/min(rpm)
2	1	.75	50	190/380	3000

Ins	Rating	Dimension in	Approx Weight	Bearings
F	CONT.	inch	44 lbs.	DE: 6205ZZ NDE: 6205ZZ

Totally Enclosed Fan-Cooled Type. Squirrel-Cage Rotor.

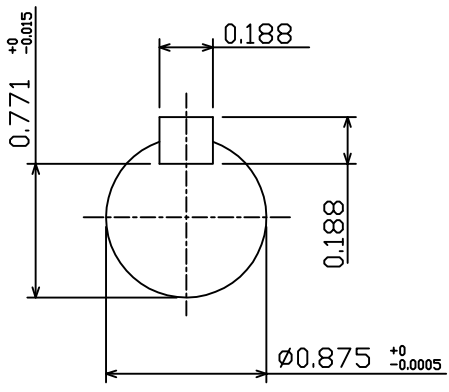
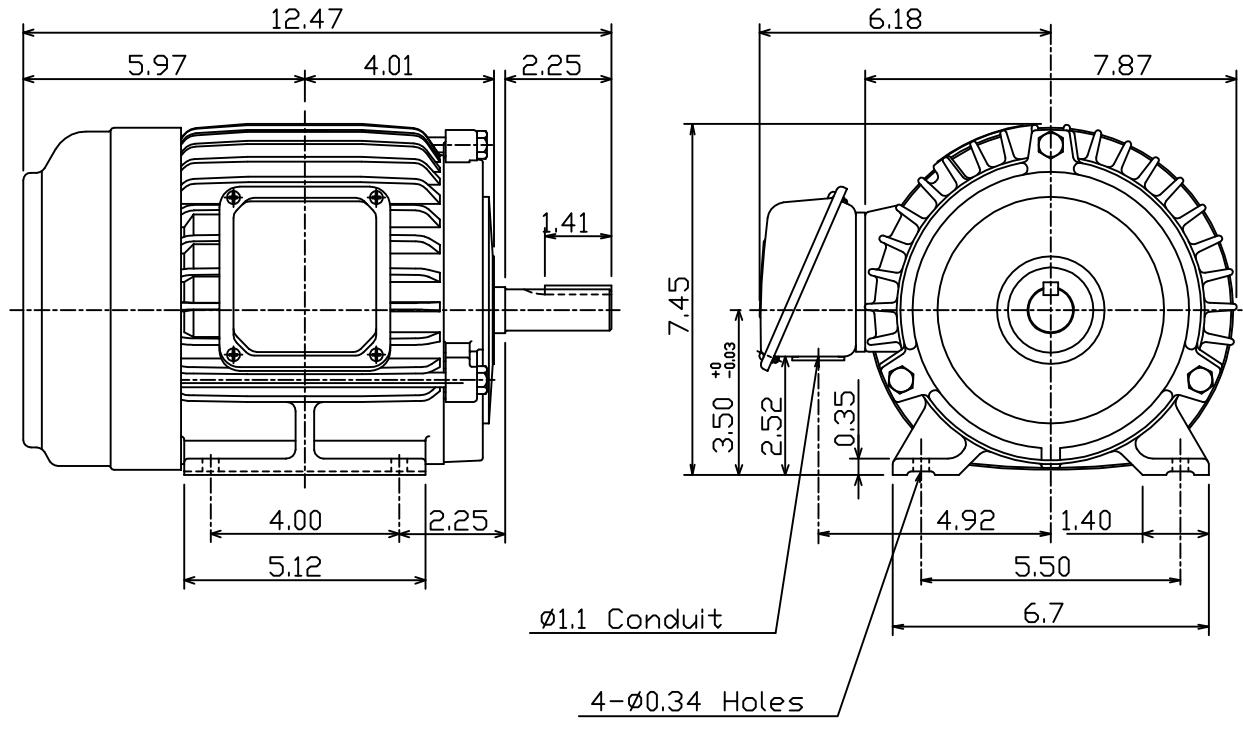

DWN.	J.H.LIANG	05-20-99
CHKD.	C.S.LO	05-26-99
APPD.	Y.B.HUANG	05-26-99



DWG NO.  
31049D187100