

DATE  
MAY 28, 2009  
CATALOG # DTP0054

OUTLINE DIMENSIONS  
3-PHASE INDUCTION MOTOR

MOTOR TYPE:  
ASGH  
FRAME NO. 184T

Pole	HP	kW	Hz	VOLT	Syn.Speed r/min(rpm)
4	5	3.73	60	230/460	1800

Ins	Rating	Dimension in	Approx Weight	Bearings
F	CONT.	inches	77 lbs.	DE: 6206ZZC3NDE: 6205ZZC3

Open Protected Drip-Proof Squirrel Cage Rotor.

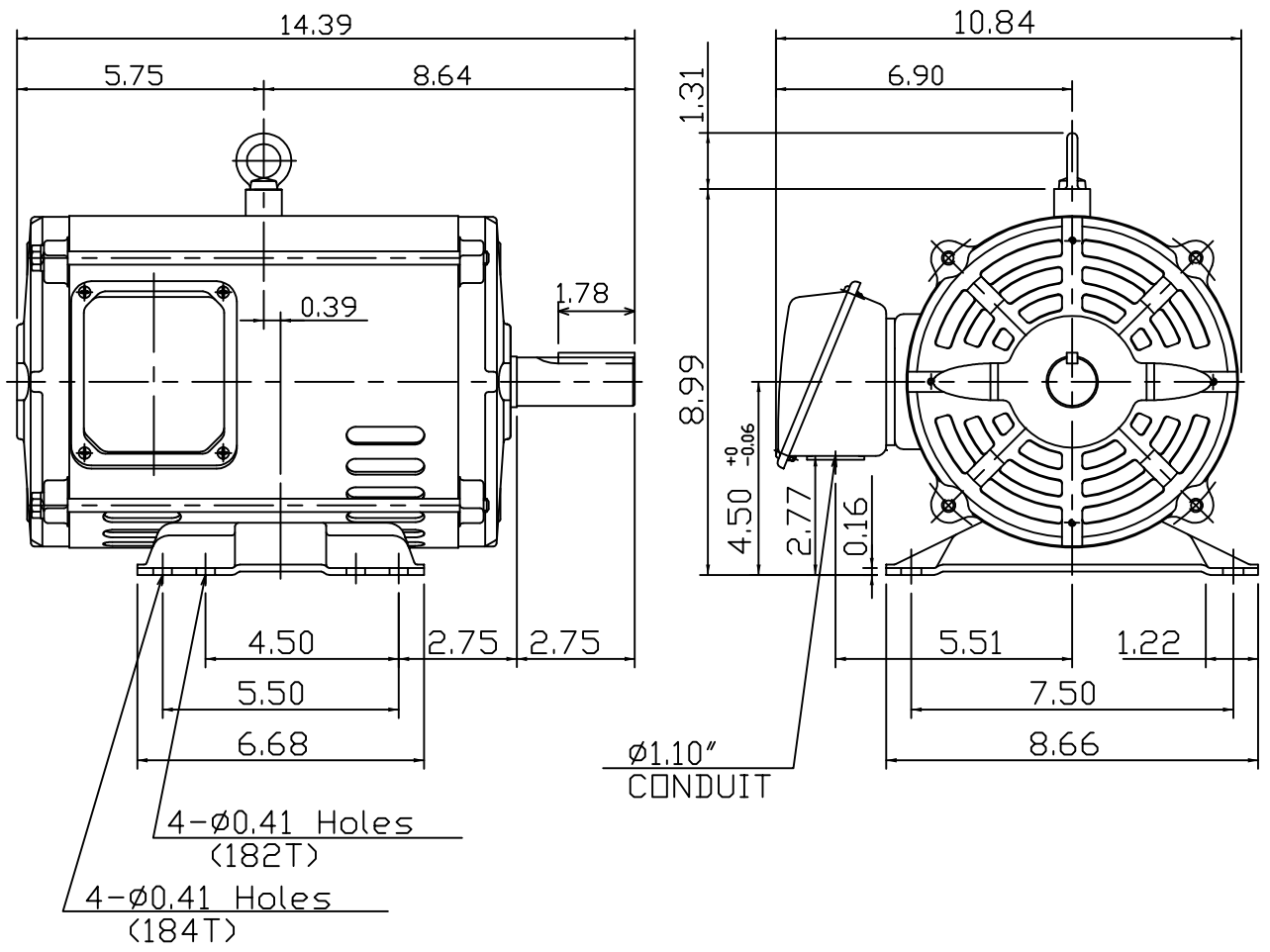

DWN.	J.H.LIANG	04-28-08
CHKD.	H.C.YAN	05-05-08
APPD.	M.C.TSAI	05-05-08



DWG NO.  
31049R170010